



# ZTD

WITH DLC3020f  
LEVEL CONTROLLER

## DISPLACER LEVEL TRANSMITTER

Operation Manual

ZTD - DT - JS - 1045 - 2020f



## Preface

Thank you for choosing the products of Dandong Top Electronics Instrument (Group) Co., Ltd.

This operation manual provides you with important information on installation, connection and commissioning as well as on maintenance, troubleshooting and storage. Please read it carefully before installation and commissioning and keep it as part of the product near the meter for easy reading.

This manual can be downloaded by entering the version number at [www.ddtop.com](http://www.ddtop.com).

If the instructions are not followed, the protection provided by the meter may be destroyed.

### Trademark, Copyright and Restriction Instructions

Dandong Top Electronics Instrument (Group) Co., Ltd.®, Dandong Top Pump Co., Ltd.®, DDTOP® are registered trademarks of the company.

The performance specifications of the meter are effective as of the date of publication and are subject to change without notice. Dandong Top Electronics Instrument (Group) Co., Ltd. reserves the right to modify the products described in this manual at any time without prior notice.

### Quality Assurance

Dandong Top Electronics Instrument (Group) Co., Ltd. guarantees that all displacer level transmitters have no defects in materials and manufacturing processes within one year from the date of delivery.

During the warranty period, if the product returns with quality problems and the claim is determined by the manufacturer to be within the scope of warranty, Dandong Top Electronics Instrument (Group) Co., Ltd. is responsible for repair or replacement of the buyer (or owner) free of charge.

Dandong Top Electronics Instrument (Group) Co., Ltd. is not responsible for the costs caused by improper use of equipment, labor claims, direct or subsequent damage and installation and use of equipment. In addition to the special written warranty certificate for certain products of Dandong Top Electronics Instrument (Group) Co., Ltd., Dandong Top Electronics Instrument (Group) Co., Ltd. does not provide any express or implied warranty.

### Quality

Dandong Top Electronics Instrument (Group) Co., Ltd. has passed the ISO9001 quality system certification. The whole process of product production is strictly in accordance with the scope of the quality system, providing the strongest guarantee for product and service quality.

## CONTENTS

|   |    |
|---|----|
| 1 Safety Tips .....   | 4  |
| 1.1 Explosion may result in death or serious injury .....                                     | 4  |
| 1.2 Process leaks can cause serious injury or death.....                                      | 4  |
| 1.3 Failure to follow safe installation guidelines may result in death or serious injury..... | 4  |
| 2 Product Instructions .....  | 4  |
| 2.2 Operating Principle .....   | 5  |
| 2.3 Packing.....  | 5  |
| 2.4 Hoist and Transportation .....  | 5  |
| 2.5 Warehousing .....   | 5  |
| 3 Technical Feature .....   | 5  |
| 3.1 Main Performance .....  | 5  |
| 3.2 Main Parameters.....  | 5  |
| 4 Dimension Schematic .....   | 5  |
| 5 Unpacking and Inspection .....  | 6  |
| 5.1 Unpacking Inspection Notice.....  | 6  |
| 5.2 Check Content .....   | 7  |
| 6 Installation .....  | 7  |
| 6.1 Installation Tool.....  | 7  |
| 6.2 Installation Technical Requirements.....  | 7  |
| 6.3 Installation Operation Process.....   | 8  |
| 7 Commissioning .....   | 11 |
| 7.1 Preparation for Commissioning.....  | 11 |
| 7.2 Electrical Wiring.....  | 12 |
| 7.3 Commissioning Operation Process.....  | 13 |
| 9 Failure Analysis and Troubleshooting.....   | 25 |

## 1 Safety Tips

It is expressly prohibited to modify or change products for safety reasons, repair or replacement only allows the use of accessories specified by the manufacturer.

### 1.1 Explosion may result in death or serious injury

When installing equipment in an explosive atmosphere, be sure to follow applicable local, national, international standards, codes, and procedures. Be sure to install the equipment in Intrinsically safe or non-flammable site operating procedures.

### 1.2 Process leaks can cause serious injury or death

Care should be taken to lift the transmitter. If the process seal is damaged, the medium may leak at the joint.

### 1.3 Failure to follow safe installation guidelines may result in death or serious injury

The operations described in this manual are performed by professionally trained and qualified professionals or end-user specialized professionals to complete.

## 2 Product Instructions

### 2.1 Main Structure of Product-Figure 1

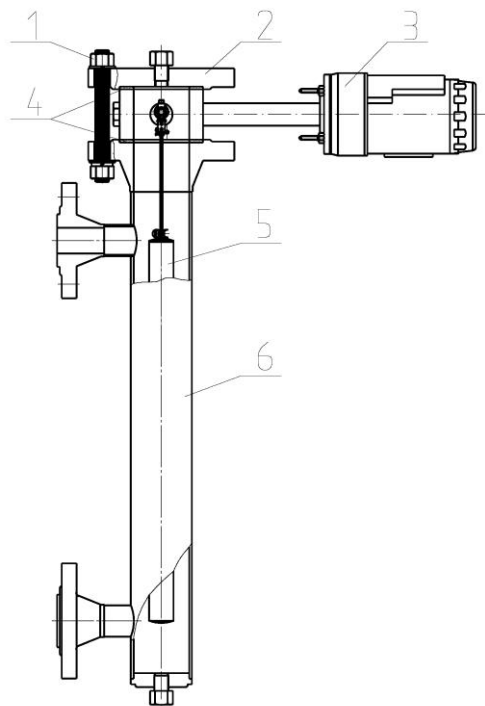

1. Fasteners, including bolt and nut washers
2. Flange cover, can be equipped with venting parts according to user requirements
3. Transmitter, 360° rotation, 8 viewing positions
4. Seal, two pieces
5. Displacer, buoyancy measuring element
6. Chamber

## 2.2 Operating Principle

The change of the level of the measured medium causes the buoyancy of the inner cylinder to change, and the change is transmitted to the torque tube assembly, so that the torque tube rotates at an angle with the mandrel. A sensing system coupled to the torsion spool produces a voltage signal. The level controller electronic component measures the level signal and provides a 4-20 mA current output. The microcontroller measures the ambient temperature to compensate for changes in liquid density due to process temperature changes. The LCD displays information such as analog output, process variables, process temperature (RTD required), torque tube rotation angle, and percentage of level positions.

## 2.3 Packing

Please send the packaging waste to a special recycling agency.

## 2.4 Hoist and Transportation

Please select qualified hoisting equipment and lifting straps, and pay attention to safety.

## 2.5 Warehousing

Storage temperature -20°C~40°C; Storage humidity ≤40%

# 3 Technical Feature

## 3.1 Main Performance

3.1.1 Has passed the national explosion-proof certification

Certification mark: Intrinsically safe type Exia II CT5/T6 Ga

Explosion-proof type Exd II CT5/T6 Gb

3.1.2 Product executive standards

GB/T13969 Displacer Type Level Meter

Q/AMM 013 Displacer Level Transmitter

## 3.2 Main Parameters

3.2.1 Power supply: 12~30V DC; reverse polarity protection in the controller

3.2.2 Output signal: Fieldbus Foundation

## 4 Dimension Schematic -Figure 2

**If the order is required to be a special size, the actual size will prevail.**

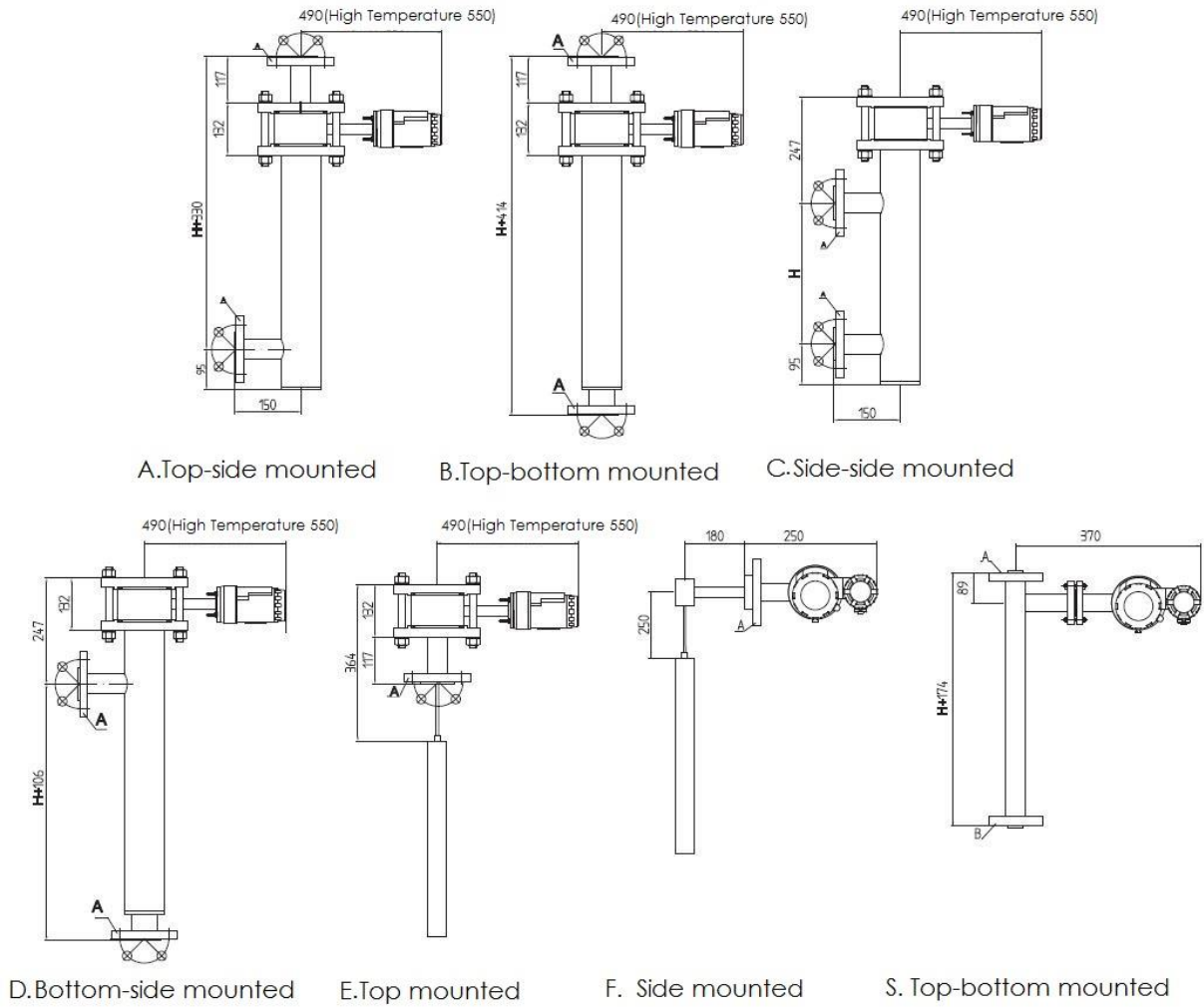

Figure 2 Dimension Schematic

## 5 Unpacking and Inspection

### 5.1 Unpacking Inspection Notice

5.1.1 Check whether the product nameplate (Figure 3) is consistent with the supply list information.

○ **Displacer Level Transmitter** ○

**Model:**

|                          |    |                    |                                     |                     |
|--------------------------|----|--------------------|-------------------------------------|---------------------|
| Nominal Pressure         |    | Design Temperature | ≤                                   | °C                  |
| Range                    | mm | Float Diameter     | Φ                                   | mm                  |
| Float Weight             | kg | Output Signal      | FF                                  |                     |
| Density of light medium  |    | g/cm <sup>3</sup>  | <input checked="" type="checkbox"/> | Ex ia II C T5/T6 Ga |
| Density of heavy medium  |    | g/cm <sup>3</sup>  | <input checked="" type="checkbox"/> | Ex d II C T5/T6 Gb  |
| Accuracy                 |    | IP66               | Tag No.                             |                     |
| Date & No. of Production | /  |                    |                                     |                     |

○ **Dandong Top Electronics Instrument (Group)** ○  
Co., Ltd  10F213-21

Figure 3 Product Nameplate

5.1.2 According to the packing list, check the quantity of each part and the material is correct.

## 5.2 Check Content

5.2.1 Check the appearance of the instrument for defects, damage and other abnormal conditions.

5.2.2 If the ZTD transmitter and other parts are packaged separately, before installing the inner cylinder, please remove the two damping rubber rings on the inner cylinder (Figure 4).

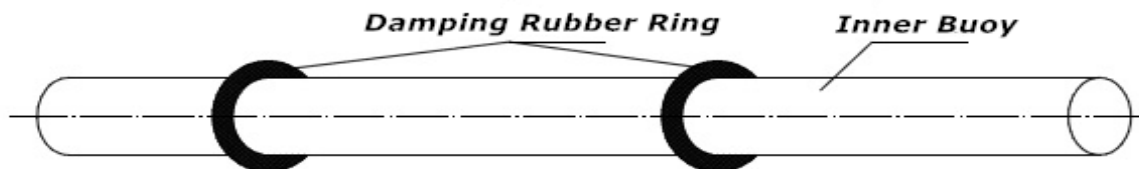

Figure 4 Damping Rubber Ring

## 6 Installation

### 6.1 Installation Tool

6.1.1 Wrenches, flange gaskets and flange bolts for process connections.

6.1.2 Level

### 6.2 Installation Technical Requirements

6.2.1 When installing the measuring chamber, the axis of the outer cylinder side flange must be perpendicular to the horizontal plane (Figure 5). If the ZTD transmitter and the remaining parts are packaged separately, install the parts according to the position shown in Figure 1. If it has been installed as a whole, follow 6.2.3-5.

6.2.2 Transmitter and inner cylinder installation: Use the connector pull ring on the inner cylinder (Figure 6), insert the connector into the top of the transmitter lever, and then turn the pull ring to the locked position. Locked on the lever (Figure 7)



Figure 5 Unlock



Figure 6 Latch

6.3 Installation Operation Process - Figure 7





Figure 7 Installation

6.3.1 Remove the bolt and nut connecting the flange cover and the outer cylinder, take out the sealing gasket, and place one gasket on the upper flange sealing surface of the outer cylinder (Figure 7-1);



Figure 7-1

6.3.2 Connect the inner cylinder and the transmitter according to 6.2.2 and put it into the outer cylinder. Ensure that the ring flange of the transmitter is in good contact with the gasket (Figure 7-2);



Figure 7-2

6.3.3 Place the other gasket on the flange cover sealing surface and install the flange cover on the transmitter ring flange. Ensure that the transmitter ring flange is in good contact with the gasket. Align the flange bolt holes (Figure 7-2).

6.3.4 Install the bolts and nuts that connect the flange cover to the outer cylinder and alternately tighten the nuts (Figure 7-3).

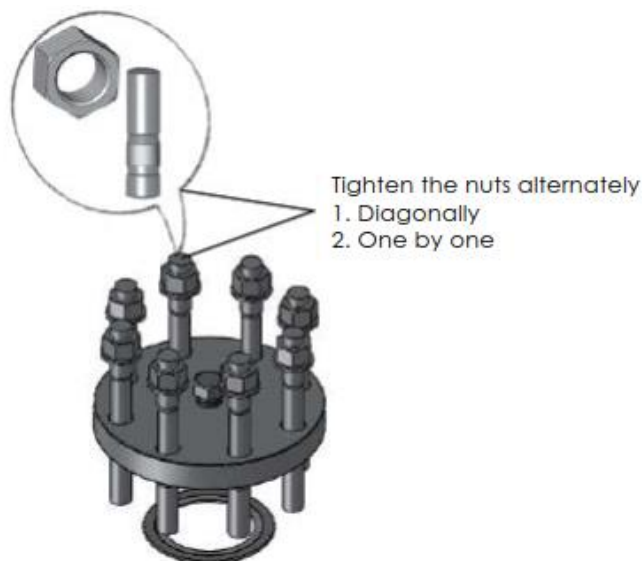

Figure 7-3

6.3.5 Install the outer cylinder side flange on the device, and ensure that the flange and the gasket are in good contact (Figure 7-4).

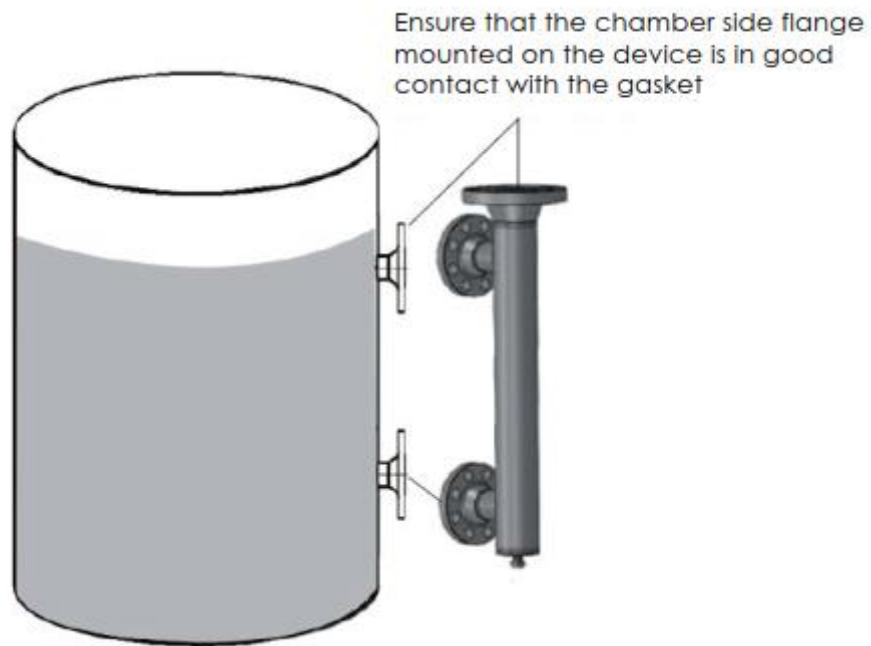

Figure 7-4

## 7 Commissioning

### 7.1 Preparation for Commissioning

#### 7.1.1 Commissioning Tool

- 1) Power supply
- 2) Communicator supports the FF bus protocol (Rosemount 275, 375, 475)

#### 7.1.2 Slider Lock

Before calibrating the DLC3020f level controller, press and hold the arrow position slider and slide it in the direction of the arrow to the other end, and the slider enters the positioning slot to lock (Figure 8).



Figure 8

## 7.2 Electrical Wiring

7.2.1 Unscrew the power terminal box cover (Figure 9) and connect the current signal lines (Figure 10). Where T is the test terminal; + is connected to the positive pole of the power supply, - is connected to the negative pole of the power supply; R1, R2 is connected to the PT100 (temperature sensor, if any); the internal grounding wire is connected to the outer casing of the armored cable (if any).



Figure 9

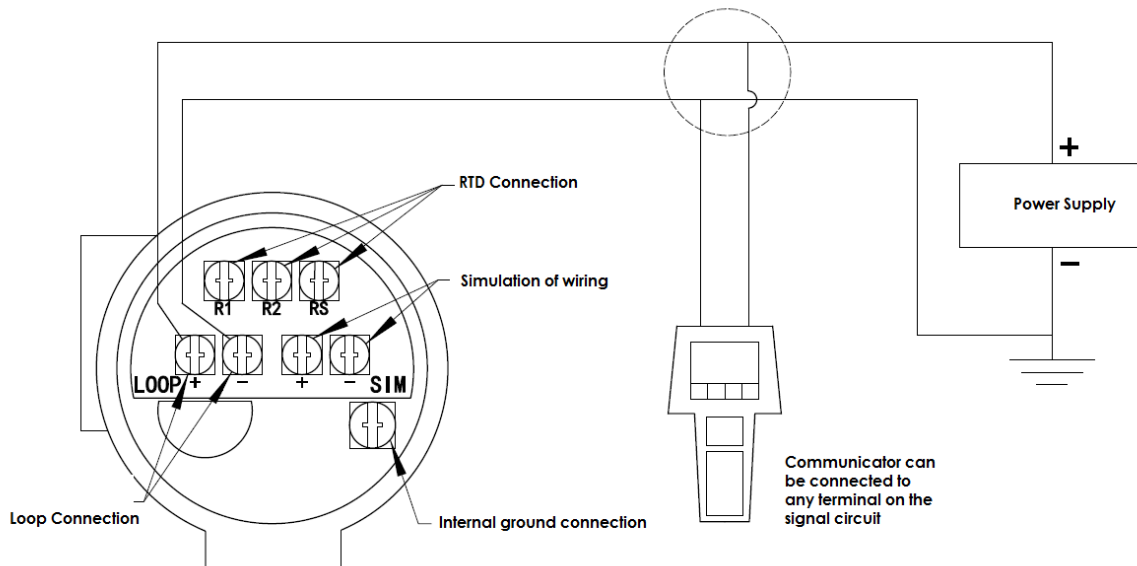

Figure 10

7.2.2 After the wiring is completed, check the polarity of the wiring correctly. The instrument case must be well grounded, and then the 24VDC standard power supply is turned on.

7.2.3 When communicating with protocol, the power supply voltage of the intelligent liquid level controller must be  $\geq 17.75\text{VDC}$ . If it is lower than this voltage, the configuration information will be considered incorrect.

7.2.4 It is recommended to use communicator supporting the HART475 communication protocol for commissioning.

### 7.3 Commissioning Operation Process

#### 7.3.1 Precautions before Commissioning

- 1) The instrument should not be subjected to strong vibration and shock, especially for the lever with the inner cylinder, and should not be pulled hard to avoid damage to the torque tube.
- 2) The instrument shall not participate in impactful process tests such as air sweeps performed before the device is put into production.

7.3.2 During commissioning, if water is used as the medium (non-measured medium), the following two conditions will occur:  $\rho_{\text{medium}} < \rho_{\text{water}}$  and  $\rho_{\text{medium}} > \rho_{\text{water}}$ . But regardless of the density of the medium, you can pass the formula:

$h_{\text{Water injection height}} = \rho_{\text{medium}} \cdot H_{\text{full scale height}} / \rho_{\text{water}}$  Calculate the corresponding water injection height and the corresponding output current value.

**※The meter has been calibrated before leaving the factory.**

#### 7.3.3 Enter the configuration and tuning process

AMS Device Manager and Field Communicator for configuration wizard and tuning process steps.

##### 7.3.3.1 Setup Wizard

|                       |                          |
|-----------------------|--------------------------|
| AMS Device ManagerAMS | Configure > Guided Setup |
| Field Communicator    | Configure > Guided Setup |

Enter the instrument settings from the Setup Wizard menu, as shown in Figure 11, for parameters such as sensor length, volume, density, and liquid being measured. Follow the prompts to set up the DLC3020f.

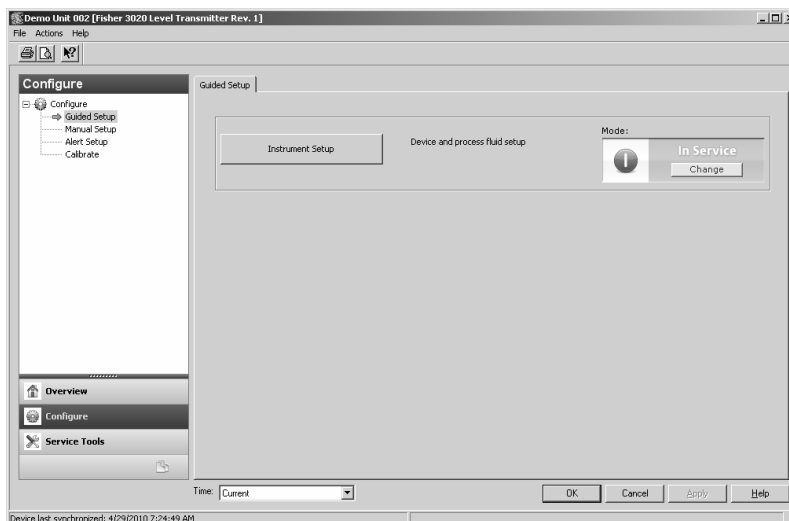

Figure 11 Setup Wizard

### 7.3.4 Maintenance Settings

|                    |                          |
|--------------------|--------------------------|
| AMS Device Manager | Configure > Manual Setup |
| Field Communicator | Configure > Manual Setup |

The Maintenance Setup menu allows you to set the device type, the type of liquid to be measured, the instrument display type, and the scrolling information enable control, as described in the following submenus.

#### 7.3.4.1 Maintenance Equipment

|                    |                                  |
|--------------------|----------------------------------|
| AMS Device Manager | Configure > Manual Setup>Device  |
| Field Communicator | Configure > Manual Setup> Device |

The maintenance setup device options are shown in Figure 12 and include settings for the following main parameters

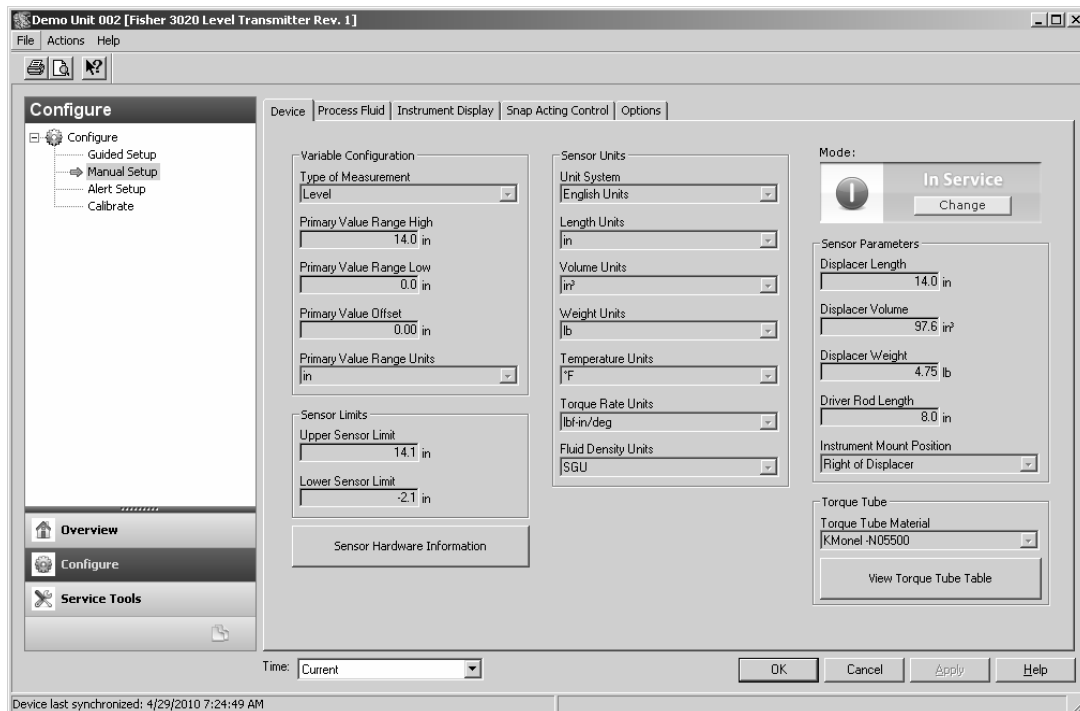

Figure 9 Maintenance Equipment Options

Type of Measurement— Level or Interface

Upper limit of the main variable range - the highest value of the currently measured process variable

Lower limit of the range of the main variable - the lowest value of the currently measured process variable

Main Variable Offset - Integral offset applied to level/interface measurement

Primary variable units - Primary variable units, primary variable range units and sensor upper and lower limit units.

Sensor upper and lower limits

Sensor Upper Limit - Indicates the maximum available variable at the high end of the primary variable range

Sensor lower limit - indicates the smallest available variable with a high range of primary variables

Sensor units-sets the current sensor units

### 7.3.4.2 Process Fluid

|                    |  |
|--------------------|--|
| AMS Device Manager | Configure > Manual Setup>Process Fluid |
| Field Communicator | Configure > Manual Setup>Process Fluid |

Select Configure > Manual Setup>Process Fluid to enter the Process Fluid menu (shown in Figure 13) and enter the Process Fluid menu settings to set the temperature compensation and measurement mode.



图 13 Figure 13

Process Fluid

Fluid Name

Fluid Density

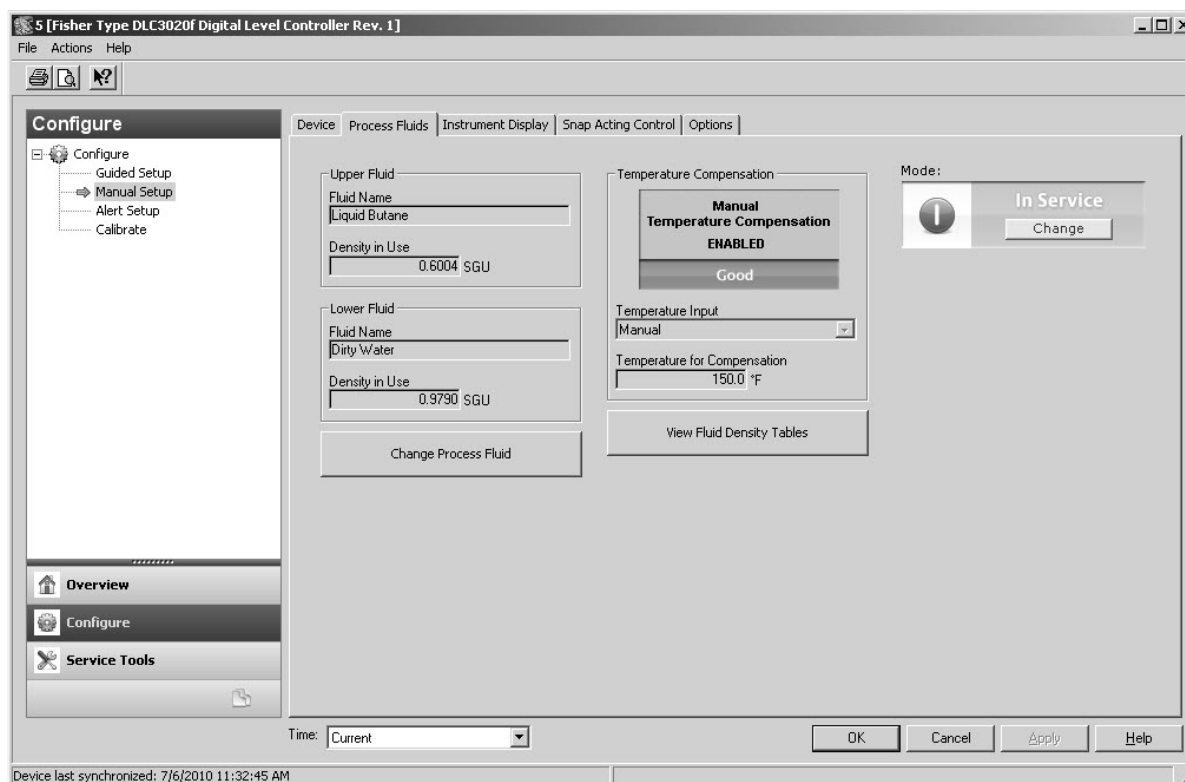
Change process fluid

Change Process Fluid - When the fluid name, density, or operating temperature is changed, it can be changed through this menu.

Temperature Compensation

If temperature compensation is selected, the following information is required:

Temperature input - choice of none, manual input, AO module or RTD.

When temperature compensation is enabled, the temperature value can be entered manually, by a temperature transmitter (AO module) of the fieldbus or by an RTD input.

Fluid Density

Current temperature compensation information can be viewed through the fluid density table.

### 7.3.4.3 Instrument Display

|                    |   |
|--------------------|---|
| AMS Device Manager | Configure > Manual Setup>Instrument Display |
| Field Communicator | Configure > Manual Setup>Instrument Display |

Select Configure > Manual Setup > Instrument Display to enter the instrument display menu (as shown in Figure 14)



图 14 Figure 14

#### Display Option

Select the display type to display only the main variable value, only the range percentage or alternate between the two.

Display the units of the main variable

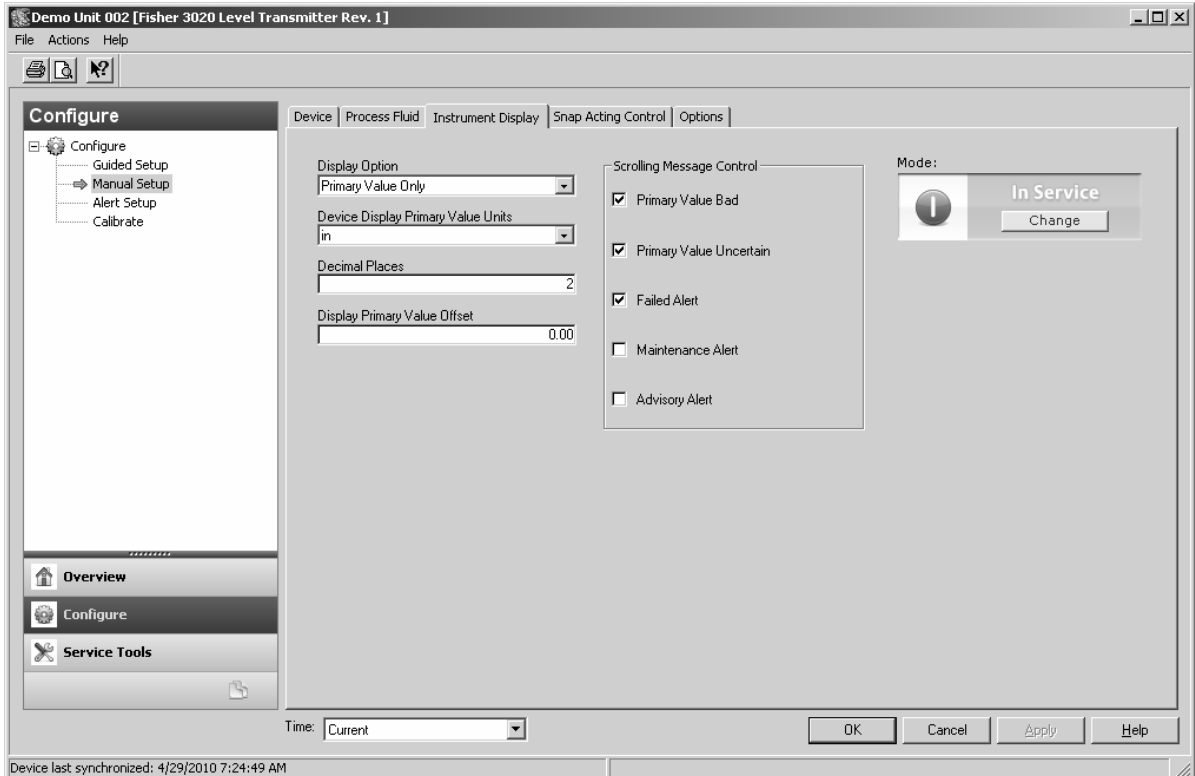
The number of decimal places displayed in the main variable

Main Variable Offset

Correction of LCD values by inputting master variable offsets

Scrolling message control

A scrolling message can be displayed on the LCD. The message can be selected from, Master Variable Exception, Master Variable Value Uncertain, Failure Alarm, Maintenance Alarm, Advanced Alarm.

#### 7.3.4.4 Scrolling Message Control

|                    |  |
|--------------------|--|
| AMS Device Manager | Configure > Manual Setup>Snap Acting Control |
| Field Communicator | Configure > Manual Setup>Snap Acting Control |

Select Configure > Manual Setup > Instrument Display to enter the scrolling information control menu (as shown in Figure 15)





图 15 Figure 15

### Scrolling Message Control

The DLC3020f can scroll through the main variables while displaying other information about the main variables, and when the scrolling display value is enabled, it can display the alarm status of the current PV value.

Rolling Message Display Control-Enables or disables rolling alarm message display.

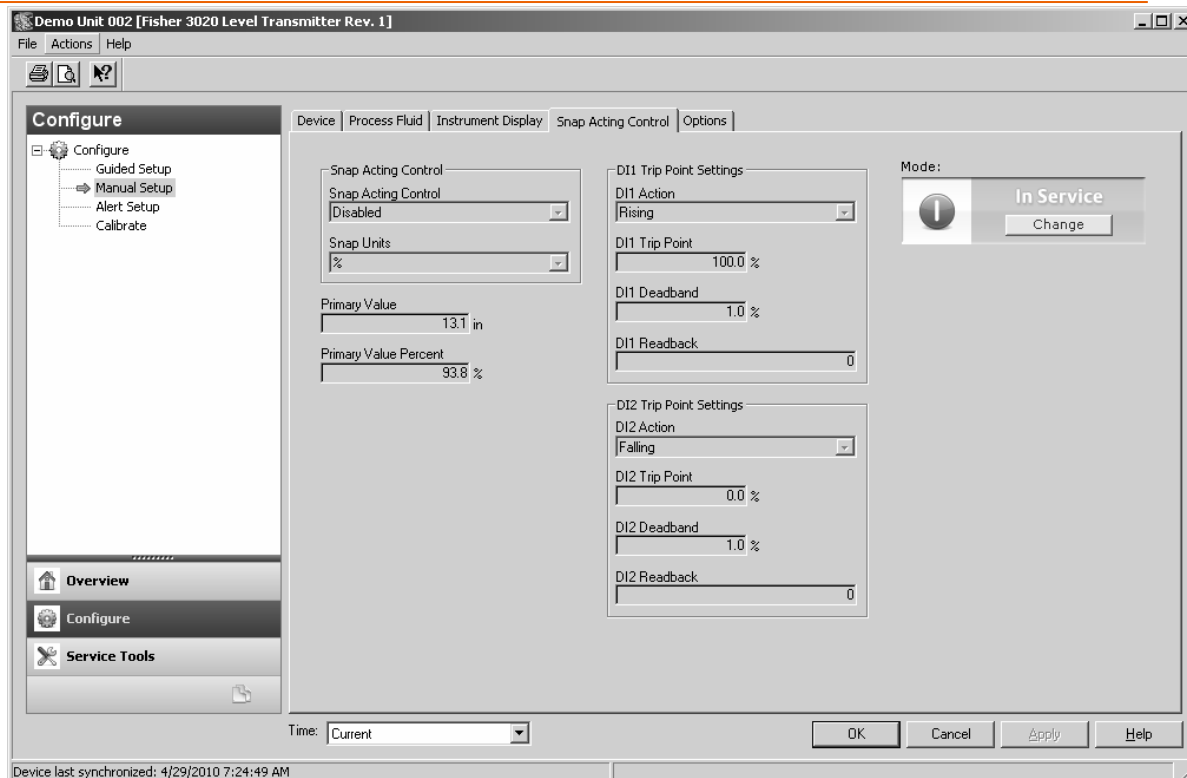
Scrolling display of units - engineering units or range percentages

Main variable value

Main variable engineering unit

D11 trigger point setting

Set DI1 or DI2 trigger level value

DI1 output enable console - output enable or loss

DI1 trigger point - DI1 output control activates when the liquid level is below the level set by DI1

DI1 Dead band - Enters the set dead band. This is the jump point away from the DI1 gap.

When the trigger is activated, the trigger is cancelled only if the level rises or falls beyond the distance of the dead band.

DI1 message return - indicates the status of the snap trigger point. 0 indicates that the DI1 trigger is inactive. 1 indicates that the DI1 trigger is active

Set DI1 or DI2 trigger level value

DI2 output enable console - output enable or loss

DI2 trigger point - DI2 output control activates when the level is below the level set by DI1

DI2 Dead band - Enters the set dead band. This is the jump point away from the DI2 gap.

When the trigger is activated, the trigger is cancelled only if the level rises or falls beyond the distance of the dead band.

DI2 message return - indicates the status of the trigger point. 0 indicates that the DI2 trigger is inactive. 1 indicates that the DI2 trigger is active.

### 7.3.5 Alarm Settings

|                    |                         |
|--------------------|-------------------------|
| AMS Device Manager | Configure > Alert Setup |
| Field Communicator | Configure > Alert Setup |

The DLC3020f offers two types of alarms, Meter Alarms and Plant Web Alarms. See Figure 16. Instrument Alarm Conditions

When alarms are enabled, operational and performance problems may occur. The user must open an AMS Device Manager or Field Communicator on the host computer to view the status of these alarms.

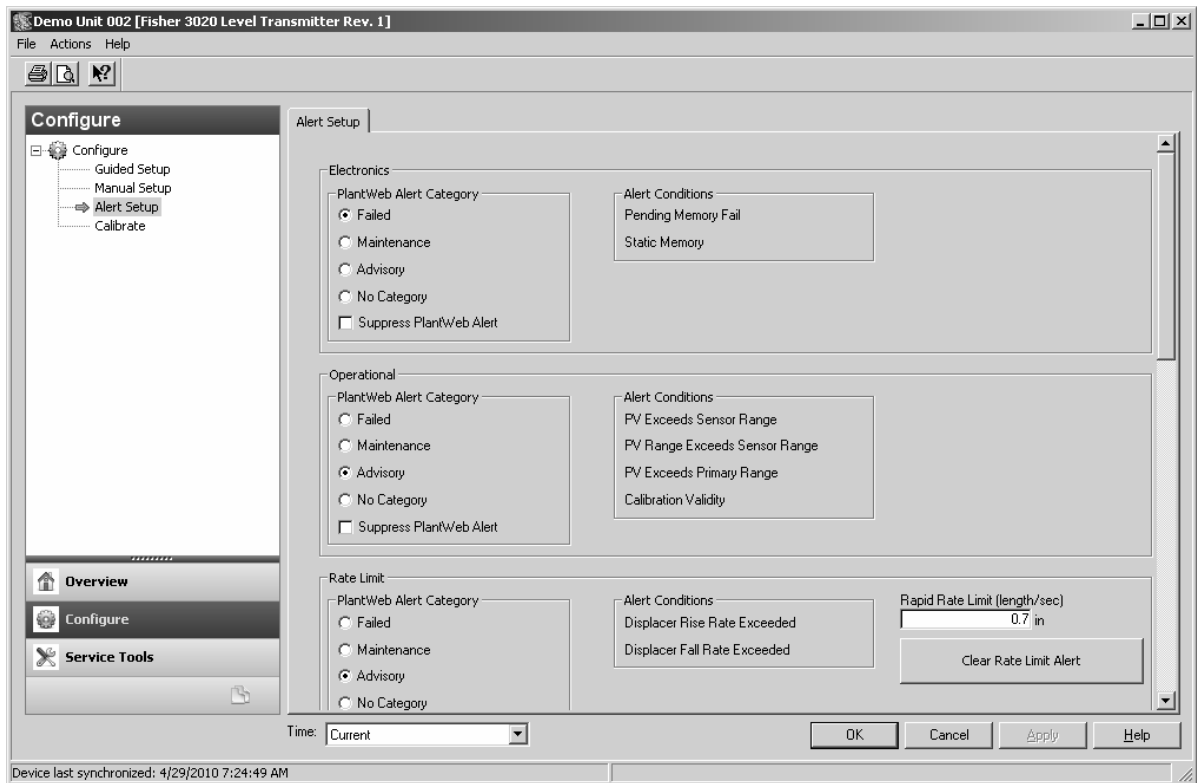

Figure 16

### 7.3.6 Calibration

#### 7.3.6.1 Calibration Wizard

|                    |  |
|--------------------|--|
| AMS Device Manager | Configure > Calibrate > Guided Calibrations                                  |
| Field Communicator | Configure > Calibrate > Full Calibration (Bench) or Full Calibration (Field) |

Select Configure > Calibrate > Guided Calibrations to access the Calibration Wizard menu (Figure 17) providing either a field calibration or bench calibration method.



图 17 Figure 17

### User Calibration

Name - Media Name

Date - Calibration date

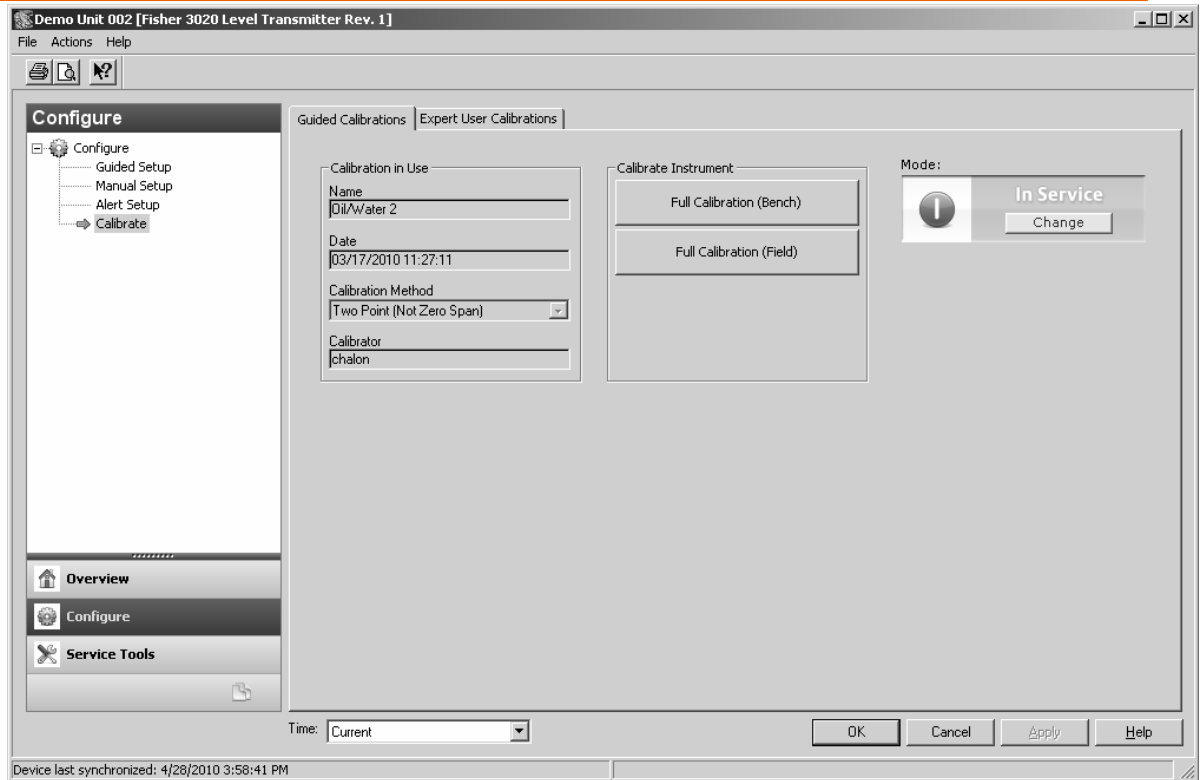
Calibrator - Name of instrument calibrator

Calibration Method - Calibration Method

### Instrument Calibration

Select Factory Calibration or Field Calibration to calibrate the instrument using AMS Device Manager, Field Communicator, or other host system.

#### 7.3.6.2 Factory Calibration

|                    |  |
|--------------------|--|
| AMS Device Manager | Configure>Calibrate>Expert User Calibrations |
| Field Communicator | Configure>Calibrate>Expert User Calibrations |

Select Configure > Calibrate > Expert User Calibrations to access the Factory Calibration (Figure 18) menu, which allows you to select multiple calibration methods. Allows the AMS Device Manager (or Field Communicator will other host systems) to calibrate the instrument.

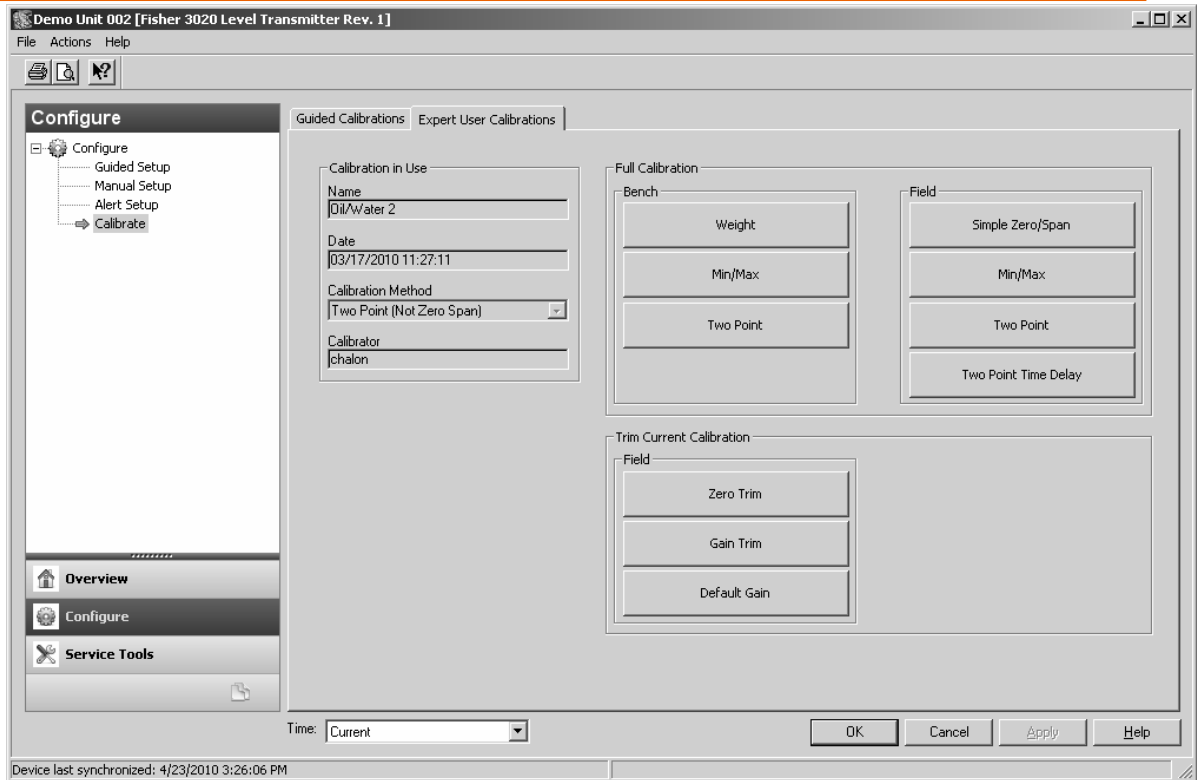

Figure 18

Measured Medium Name

Date- Indicates the appropriate calibration was performed.

Calibrator-Indicates who performed the calibration.

Calibration Method - Indicates the calibration method

All Calibration Methods

Hanging Weight Calibration

Min/Max Calibration

Two-point calibration

Zero Full Calibration

#### 7.4 475 DLC3020F Communicator Calibration DLC3020F

##### 7.4.1 Connection Settings

After the circuit is connected and the hand controller communicates, the following menu is accessed.

| FieldBus Live Device List   | Address |
|---|---------|
| <div style="display: inline-block; vertical-align: middle;"> <span style="font-size: 3em; vertical-align: middle;">{</span> <span style="display: inline-block; vertical-align: middle; margin-left: 5px;">                     LAS-3020F<br/>Xxxx                 </span> </div> | 10      |

If this address is used in the field, then this address cannot be changed, if it is calibrated in the

factory, you need to output a temporary address, the temporary address range 248-251, just enter a random one in this range.

### 7.4.2 Main Interface

After entering the address, the light will enter the main screen at one end of the time.

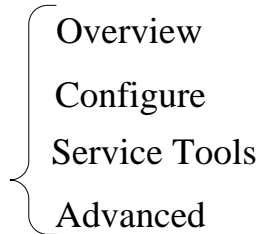

#### 7.4.2.1 Overview

The main functions in the Overview menu are View instrument status, view calibration records, restore and delete calibration records.

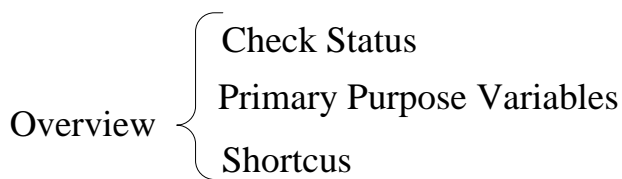

View Check Status in the Status menu

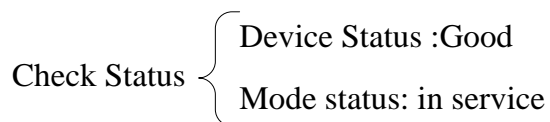

#### 7.4.2.2 Configure

Configuration menu screen

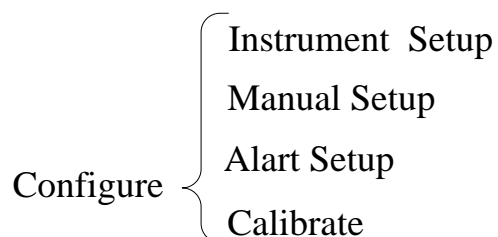

Setup wizard for basic settings.

The main functions of this menu:

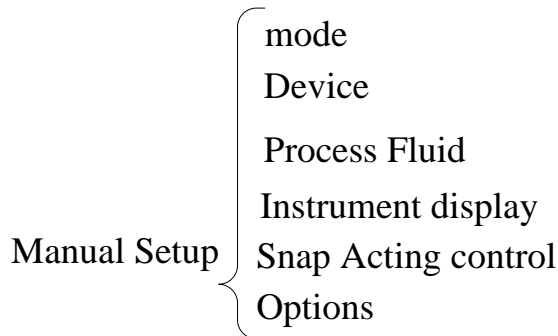

Device item (view sensor unit information, sensor parameter values, torque tube stiffness information, view hardware information).

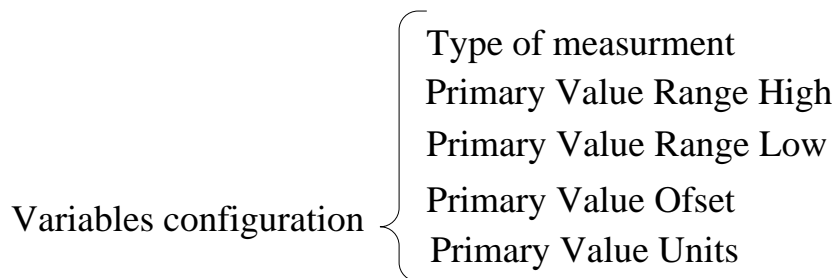
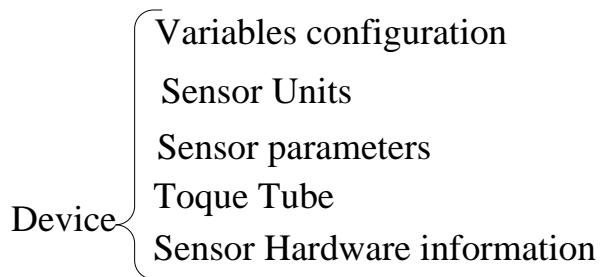

Process Fluid item to view or change the current fluid name, density and whether it is temperature compensated, density table input.

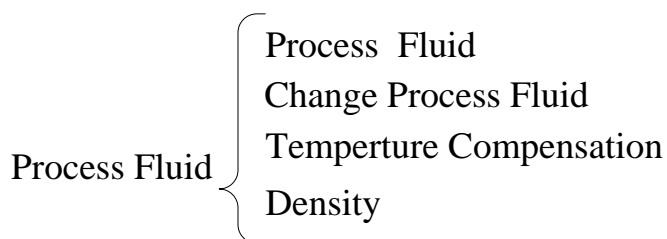

Instrument display item to display the type parameter of the dwelling variable, display the units of the main variable, the number of decimal places, and the scrolling information display control.

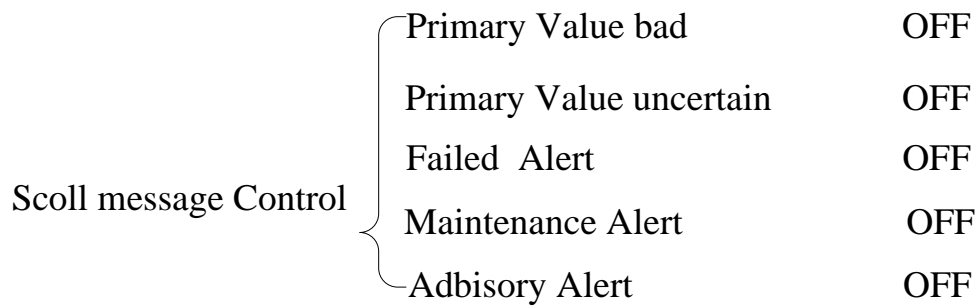
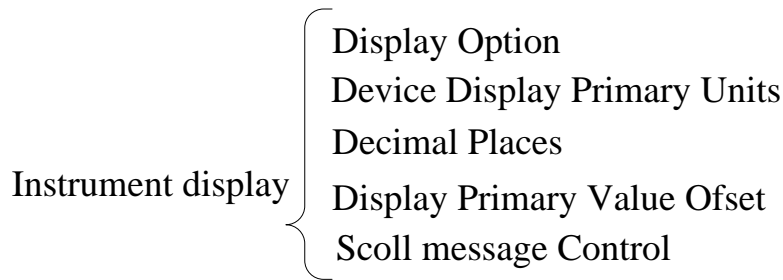

Snap Action Control can view the current master variable values, percentages.

Options can set the lock status of the meter

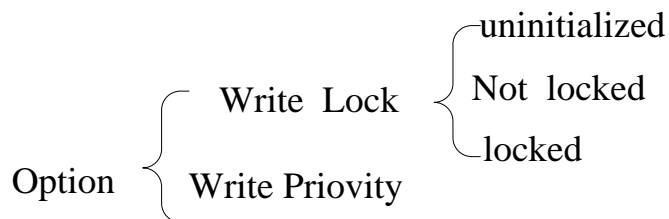

Calibrate

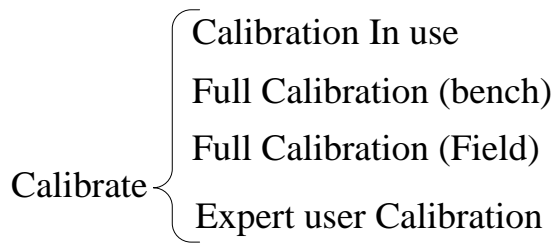

Calibration In use Current calibrator information and calibration method used

Bench (bench calibration), mainly hanging weight method

Field (field calibration), main max/min method

Expert user Calibration

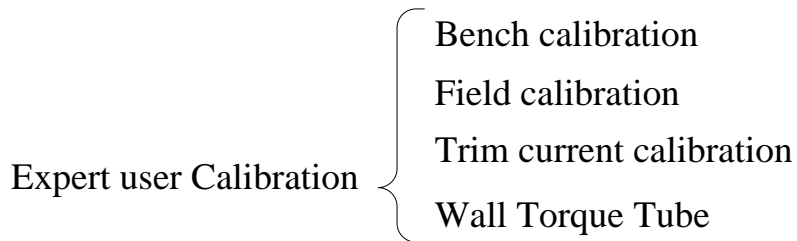

After completing the calibration to carry out zero migration, hook up the zero weight and then carry out Zero Trim.

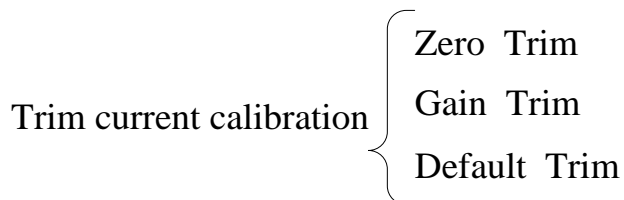

Zero Trim does a zero trigger at the end of calibration, after hanging the zero weight.

Service Tools

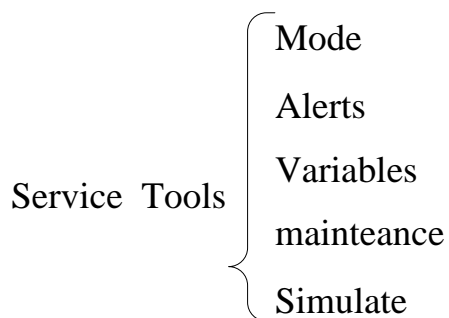



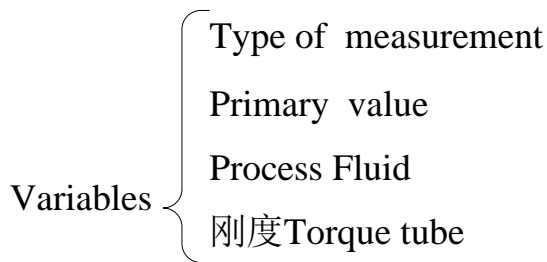

After completing the above operation, the smart level transmitter is ready for use.

\* Special attention should be paid to the uniformity of measurement units when setting up.

## 8 Precautions

8.1 The density of use should be the same as the design density. If the density changes, the parameters need to be changed again to calibrate the instrument

8.2 During the disassembly and assembly process, the torsion tube should be protected as much as possible to prevent damage to the force;

8.3 Make sure the power supply is safe and reliable, and the power supply should be connected according to the correct positive and negative poles;

8.4 Do not operate the instrument with an unsupported handheld communicator;

8.5 When the vibration is large, it is not suitable to use the displacer level transmitter;

8.6 Medium with viscosity  $\geq 500\text{mPa/s}$  is not suitable for measurement with a displacer level transmitter;

8.7 The operating temperature range of electronic components is  $-40\text{ }^{\circ}\text{C} \sim +80\text{ }^{\circ}\text{C}$ , the temperature range displayed on the LCD screen is  $-30\text{ }^{\circ}\text{C} \sim +80\text{ }^{\circ}\text{C}$  (out of range LCD display, remote transmission is normal);

8.8 After the commissioning, tighten the display and power cover to prevent the instrument from getting wet.

## 9 Failure Analysis and Troubleshooting

| Phenomenon   | Reason   | Solution   |
|--|--|--|
| <p>After power-on, the LCD has no display, no signal output</p>  | <ol style="list-style-type: none"> <li>1. The power supply polarity is reversed or the power supply is faulty;</li> <li>2. There is an open circuit in the line.</li> </ol>  | <ol style="list-style-type: none"> <li>1. Check if the power supply voltage is normal, and check if the power supply circuit has an open circuit;</li> <li>2. If there is a safety barrier in the circuit, check if the safety barrier is working properly;</li> <li>3. Connect the positive and negative power supplies correctly.</li> </ol>   |
| <p>The actual level of the device changes, and the meter indication and output do not change with the level, or the variation range is inconsistent.</p> | <ol style="list-style-type: none"> <li>1. The inner cylinder anti-vibration rubber ring is not removed, and friction occurs with the outer cylinder wall;</li> <li>2. The inner cylinder or lever is caught by the foreign object;</li> <li>3. The outer cylinder is installed without vertical friction with the inner cylinder;</li> <li>4. The inner tube connector is reversed, and the inner tube is rubbed against the outer tube wall;</li> <li>5. The locking device of the transmitter is not pushed to the unlocked position.</li> </ol> | <ol style="list-style-type: none"> <li>1. In the process of transportation, in order to prevent collision damage of the inner and outer cylinders, the inner cylinder will be installed with anti-vibration rubber ring when the factory is shipped, and the rubber ring should be taken out during the installation process;</li> <li>2. Check if there is any foreign matter in the inner cylinder and the lever, and remove the foreign matter;</li> <li>3. Correct the outer cylinder to be perpendicular to the ground;</li> <li>4. Re-install the inner cylinder correctly;</li> <li>5. Push the locking device to the unlocked position. (in the direction of the arrow)</li> </ol> |
| <p>The meter displays the output maximum or over range, and there is no change in the commissioning, and there is no change in the field indication.</p> | <ol style="list-style-type: none"> <li>1. The inner cylinder is detached;</li> <li>2. The instrument junction box is faulty;</li> <li>3. The locking device of the transmitter is not pushed to the unlocked position.</li> </ol>  | <ol style="list-style-type: none"> <li>1. Connect the inner tube</li> <li>2. Replace the junction box</li> <li>3. Push the locking device to the unlock position</li> </ol>  |
| <p>After the meter is calibrated, it is put into use and there is a deviation from the actual level value. The indication is not allowed.</p>            | <ol style="list-style-type: none"> <li>1. The process parameters are not accurate (the actual density is inconsistent with the design density);</li> <li>2. On-site heating causes the density of the medium to change;</li> <li>3. Local indication level indicator is not accurate.</li> </ol>   | <ol style="list-style-type: none"> <li>1. Re-determine the process parameters, recalibrate the meter at the new density, or modify the meter display and output using the fixed-point migration function.</li> <li>2. Adjust the temperature of the heating to prevent the density of the measured medium from changing;</li> <li>3. Check the local level gauge to determine its accurate reflection of the actual level.</li> </ol>  |

|   |   |   |
|---|---|---|
| <p>Tuning instrument is not linear, and has a large difference.</p>                             | <ol style="list-style-type: none"> <li>1. The inner tube is stuck by debris, and the range cannot be opened.</li> <li>2. The inner cylinder anti-vibration rubber ring is not removed.</li> <li>3. The power supply voltage is abnormal.</li> <li>4. Parameter calculation error during verification</li> <li>5. The locking device of the transmitter is not pushed to the unlock position.</li> </ol> | <ol style="list-style-type: none"> <li>1. Remove debris</li> <li>2. Take out the rubber ring</li> <li>3. Adjust the power supply voltage</li> <li>4. Recalculate the correct parameters.</li> <li>5. Push the locking device to the unlock position</li> </ol>  |
| <p>The header shows garbled characters and the output signal does not change.</p>               | <ol style="list-style-type: none"> <li>1. The circuit board is faulty;</li> <li>2. The power supply voltage is abnormal.</li> </ol>   | <ol style="list-style-type: none"> <li>1. Replace the meter head;</li> <li>2. Detect the power supply replacement barrier.</li> </ol>   |
| <p>When the meter is adjusted, the output current of the meter is high or low.</p>              | <ol style="list-style-type: none"> <li>1. Power failure;</li> <li>2. The meter insulation is not good.</li> </ol>   | <ol style="list-style-type: none"> <li>1. Check the power supply and replace the safety barrier;</li> <li>2. Detect the insulation of the meter terminals. If there is any problem with the insulation, replace the meter head.</li> </ol>  |
| <p>The LCD display percentage and level value do not match the actual output current value.</p> | <ol style="list-style-type: none"> <li>1. URV and LRV input errors;</li> <li>2. The instrument is not calibrated with a regular hand-held device, resulting in a digital signal that does not match the analog signal.</li> </ol>   | <ol style="list-style-type: none"> <li>1. Re-enter the URV and LRV values (URV=range; LRV=zero).</li> <li>2. Calibrate the current using the Communicator Modulo Calibration function.</li> </ol>   |
| <p>The meter displays 0%; the level changes and the meter output do not change.</p>             | <ol style="list-style-type: none"> <li>1. The meter parameter density value becomes "0";</li> <li>2. Instrument parameter torque tube stiffness is "0";</li> <li>3. The locking device of the transmitter is not pushed to the unlock position;</li> <li>4. The inner cylinder is detached or the anti-vibration rubber ring is not taken out.</li> </ol>   | <ol style="list-style-type: none"> <li>1. Re-enter the correct density value;</li> <li>2. Re-enter the torque tube stiffness value 8-30, and re-calibrate the instrument at two points;</li> <li>3. Push the locking device to the unlocked position;</li> <li>4. Reinstall the inner cylinder or remove the anti-vibration rubber ring.</li> </ol> |
| <p>The meter output continues to decrease and cannot be properly calibrated.</p>                | <ol style="list-style-type: none"> <li>1. Torque tube failure;</li> <li>2. The inner cylinder is smashed, leaked, and fed into the medium.</li> </ol>   | <ol style="list-style-type: none"> <li>1. Replace the torque tube;</li> <li>2. Replace the inner buoy</li> </ol>  |
| <p>The Communicator is not communicating.</p>   | <ol style="list-style-type: none"> <li>1. Check the model and version of the Communicator.</li> <li>2. Check if there is a problem with the power supply.</li> </ol>  | <ol style="list-style-type: none"> <li>1. Use a handheld communicator that supports the HART protocol (Rosemount 275, 375, 475);</li> <li>2. Replace the power supply;</li> <li>3. Change the safety barrier, or string 250 ohm resistor.</li> </ol>  |

## 10.1 Warning

Attention should be paid to hazardous process conditions, such as pressure inside the vessel, high temperatures, corrosive or toxic media, etc.



Refer to the instructions in section 6.3 Installation Operation and Section 7.2 Electrical Wiring to remove the parts in the reverse order of operation.

## 10.2 Waste Removal

Waste disposal should be carried out in accordance with the current guidelines in each region.

## 11 Product Certification

### Product Certification

| Certification   | Certification No.         | Descriptions   |
|---|---------------------------|--|
| <b>FM U.S. explosion-proof rating certification</b>  | ID 3008498                | XP:CL I ,DIV 1, GP ABCD, T5<br>NI:CL I ,DIV 2, GP ABCD, T5<br>DIP:CL II ,DIV 1, GP EFG, T5<br>S:CL II ,DIV 2, GP FG<br>IS:CL I , II ,III DIV 1, GP PER<br>DWG 28B57445, T5 |
| <b>CSA Certification</b>                             | 1088348<br>(016426_0_000) | CL I ,DIV 1, GP BCD, T6<br>CL I ,DIV 2, GP ABCD, T6<br>CL II ,DIV 1, 2, GP E,F,G<br>Ex ia INTRINSICALLY SAFE<br>CL I , II ,III DIV 1, GP PER<br>DWG 28B5744, T6            |